

Door cutout details

Fixed Type ACB

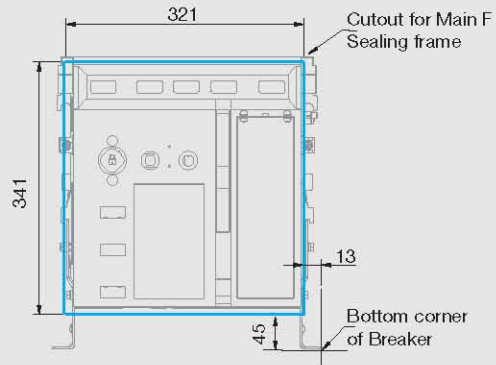
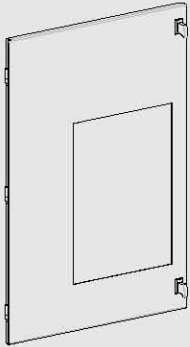

Drawout Type ACB

Door hinge on left

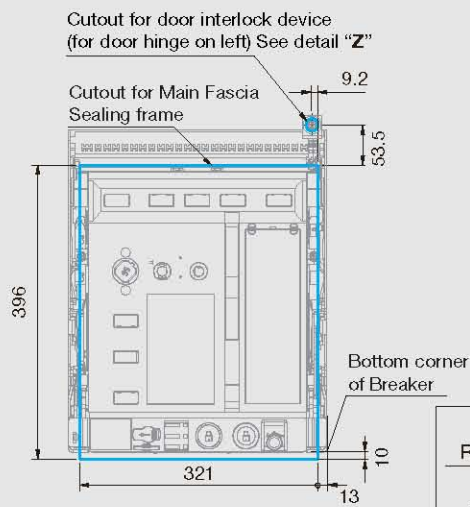
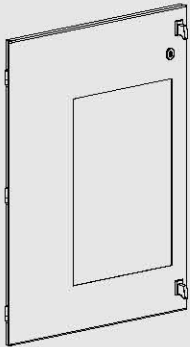

Door hinge on right

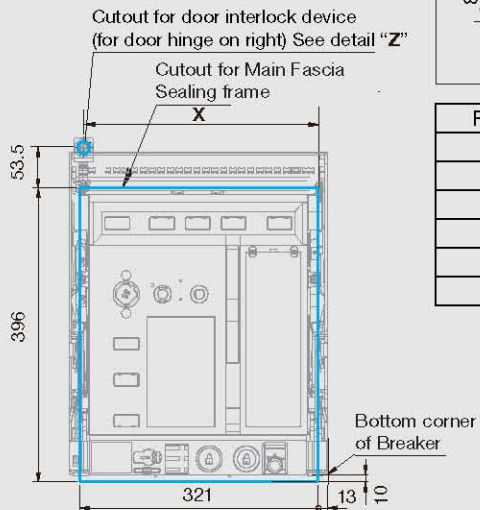
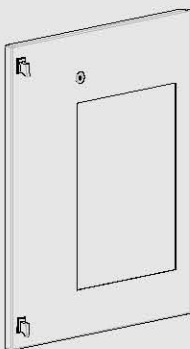

Frame	Pole	Size X
I	3	311.8
	4	411.8
II	3	411.8
	4	545.8
III	3	611.8
	4	811.8

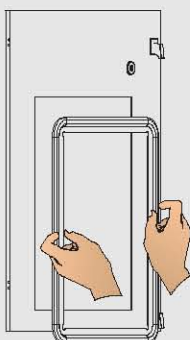

Fixing Door Sealing Frame

Function: To provide Ingress protection.

Features: hager ACB's unique dual hardness door sealing frame can be fixed to the panel door without any tools, hardware or adhesives. This offers a considerable saving in panel assembly time.

Installation: Fix the sealing frame on the panel door so that groove on the frame's outer edge fits on the edge of the panel cut-out.